

PERFORMANCE
MADE
SMARTER

Product manual

3000 series

6 mm series of temperature converters

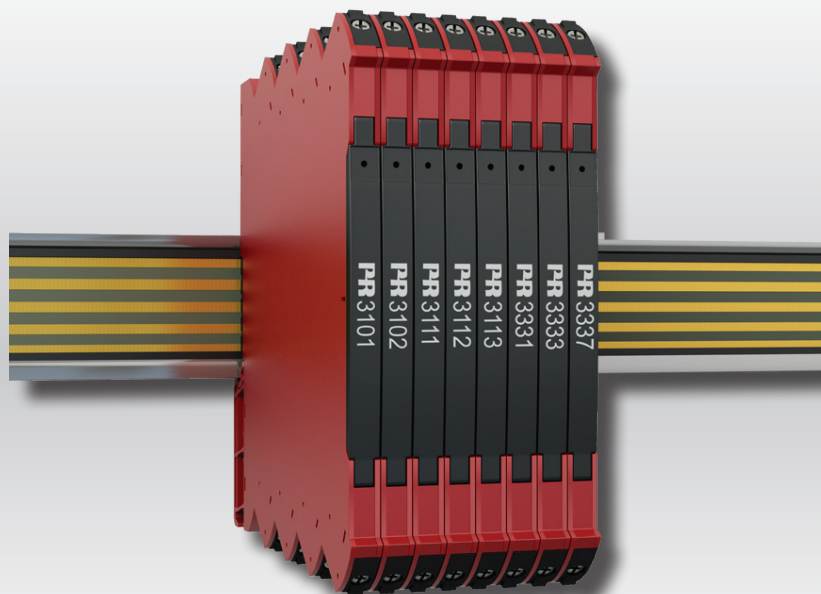

TEMPERATURE | I.S. INTERFACES | COMMUNICATION INTERFACES | MULTIFUNCTIONAL | ISOLATION | DISPLAY

Models no. 3101 / 3102 / 3111 / 3112 / 3113 /
3331 / 3333 / 3337

No. 3000V103-UK

From ser. no 131667001

PR
electronics

6 Product Pillars

to meet your every need

Individually outstanding, unrivalled in combination

With our innovative, patented technologies, we make signal conditioning smarter and simpler. Our portfolio is composed of six product areas, where we offer a wide range of analog and digital devices covering over a thousand applications in industrial and factory automation. All our products comply with or surpass the highest industry standards, ensuring reliability in even the harshest of environments and have a 5-year warranty for greater peace of mind.



Temperature

Our range of temperature transmitters and sensors provides the highest level of signal integrity from the measurement point to your control system. You can convert industrial process temperature signals to analog, bus or digital communications using a highly reliable point-to-point solution with a fast response time, automatic self-calibration, sensor error detection, low drift, and top EMC performance in any environment.



I.S. Interface

We deliver the safest signals by validating our products against the toughest safety standards. Through our commitment to innovation, we have made pioneering achievements in developing I.S. interfaces with SIL 2 Full Assessment that are both efficient and cost-effective. Our comprehensive range of analog and digital intrinsically safe isolation barriers offers multifunctional inputs and outputs, making PR an easy-to-implement site standard. Our backplanes further simplify large installations and provide seamless integration to standard DCS systems.



Communication

We provide inexpensive, easy-to-use, future-ready communication interfaces that can access your PR installed base of products. The detachable 4501 Local Operator Interface (LOI) allows for local monitoring of process values, device configuration, error detection and signal simulation. The next generation, our 4511 Remote Operator Interface (ROI) does all that and more, adding remote digital communications via Modbus/RTU, while the analog output signals are still available for redundancy.

With the 4511 you can further expand connectivity with a PR gateway, which connects via industrial Ethernet, wirelessly through a Wi-Fi router or directly with the devices using our Portable Plant Supervisor (PPS) application. The PPS app is available for iOS, Android and Windows.



Multifunction

Our unique range of single devices covering multiple applications is easily deployable as your site standard. Having one variant that applies to a broad range of applications can reduce your installation time and training, and greatly simplify spare parts management at your facilities. Our devices are designed for long-term signal accuracy, low power consumption, immunity to electrical noise and simple programming.



Isolation

Our compact, fast, high-quality 6 mm isolators are based on microprocessor technology to provide exceptional performance and EMC-immunity for dedicated applications at a very low total cost of ownership. They can be stacked both vertically and horizontally with no air gap separation between units required.



Display

Our display range is characterized by its flexibility and stability. The devices meet nearly every demand for display readout of process signals, and have universal input and power supply capabilities. They provide a real-time measurement of your process value no matter the industry, and are engineered to provide a user-friendly and reliable relay of information, even in demanding environments.

6 mm series of temperature converters 3101 / 3102 / 3111 / 3112 / 3113 / 3331 / 3333 / 3337

Table of contents

Warning	4
Symbol identification	4
Safety instructions	4
UL installation	5
cFMus installation in Division 2 or Zone 2	5
IECEX, ATEX installation in Zone 2	5
Flexible supply	7
Mounting and demounting of system 3000	8
Installation on DIN rail / power rail	9
Supply of power rail	9
Marking	9
Side label	10
Applications	11
Technical characteristics	11
Mounting / installation	11
Order codes	12
Accessories	12
Accessories for power rail devices	12
Technical data	12
Connections	16
Front led indications	17
DIP-switch configuration	18
Default configurations	18
Temperature range programming	19
Document history	20

Warning



GENERAL

To avoid the risk of electric shock and fire, the safety instructions of this guide must be observed and the guidelines followed. The specifications must not be exceeded, and the device must only be applied as described in the following. Prior to the commissioning of the device, this installation guide must be examined carefully. Only qualified personnel (technicians) should install this device. If the equipment is used in a manner not specified by the manufacturer, the protection provided by the equipment may be impaired. Until the device is fixed, do not connect hazardous voltages to the device.

To avoid explosion and serious injury: Modules having mechanical failures must be returned to PR electronics for repair or replacement.



**HAZARDOUS
VOLTAGE**

Repair of the device must be done by PR electronics A/S only.

In applications where hazardous voltage is connected to in-/outputs of the device, sufficient spacing or isolation from wires, terminals and enclosure - to surroundings (incl. neighboring devices), must be ensured to maintain protection against electric shock.



CAUTION

Potential electrostatic charging hazard. To avoid the risk of explosion due to electrostatic charging of the enclosure, do not handle the units unless the area is known to be safe, or appropriate safety measures are taken to avoid electrostatic discharge.

Symbol identification



Triangle with an exclamation mark: Read the manual before installation and commissioning of the device in order to avoid incidents that could lead to personal injury or mechanical damage.



The CE mark proves the compliance of the device with the essential requirements of the directives.



Ex devices have been approved acc. to the ATEX directive for use in connection with installations in explosive areas.

Safety instructions

Receipt and unpacking

Unpack the device without damaging it and check whether the device type corresponds to the one ordered. The packing should always follow the device until this has been permanently mounted.

Environment

Avoid direct sun light, dust, high temperatures, mechanical vibrations and shock, and rain and heavy moisture. If necessary, heating in excess of the stated limits for ambient temperatures should be avoided by way of ventilation.

The device can be used for Measurement Category II and Pollution Degree 2.

The device is designed to be safe at least under an altitude up to 2 000 m.

Mounting

Only technicians who are familiar with the technical terms, warnings, and instructions in the manual and who are able to follow these should connect the device.

Should there be any doubt as to the correct handling of the device, please contact your local distributor or, alternatively,
PR electronics A/S
www.prelectronics.com

Mounting and connection of the device should comply with national legislation for mounting of electric materials, i.e. wire cross section, protective fuse, and location.

Descriptions of input / output and supply connections are shown in this installation guide and on the side label.

The device is provided with field wiring terminals and shall be supplied from a Power Supply having double / reinforced insulation. A power switch should be easily accessible and close to the device. The power switch shall be marked as the disconnecting unit for the device.

SYSTEM 3000 must be mounted on a DIN rail according to EN 60715.

UL installation

Use 60/75°C copper conductors only.

Wire size. AWG 26-12

UL file number E314307

The device is an Open Type Listed Process Control Equipment. To prevent injury resulting from accessibility to live parts the equipment must be installed in an enclosure.

The power supply unit must comply with NEC Class 2, as described by the National Electrical Code® (ANSI / NFPA 70).

cFMus installation in Division 2 or Zone 2

FM17CA0003X / FM17US0004X Class I, Div. 2, Group A, B, C, D T4 or
Class I, Zone 2, AEx nA IIC T4 or Ex nA IIC T4

In class I, Division 2 or Zone 2 installations, the subject equipment shall be mounted within a tool-secured enclosure which is capable of accepting one or more of Class I, Division 2 wiring methods specified in the National Electrical Code (ANSI/NFPA 70) or in Canada in the Canadian Electrical Code (C22.1).

The 3000 System Isolators and Converters must be connected to limited output NEC Class 2 circuits, as outlined in the National Electrical Code® (ANSI / NFPA 70), only. If the devices are connected to a redundant power supply (two separate power supplies), both must meet this requirement.

Where installed in outdoor or potentially wet locations the enclosure shall at a minimum meet the requirements of IP54.

Warning: Substitution of components may impair suitability for zone 2 / division 2.

Warning: To prevent ignition of the explosive atmospheres, disconnect power before servicing and do not separate connectors when energised and an explosive gas mixture is present.

Warning: Do not mount or remove devices from the power rail when an explosive gas mixture is present.

IECEX, ATEX installation in Zone 2

IECEX KEM 10.0068 X. Ex nA IIC T4 Gc

KEMA 10ATEX0147 X. II 3G Ex nA IIC T4 Gc

For safe installation the following must be observed. The device shall only be installed by qualified personnel who are familiar with the national and international laws, directives and standards that apply to this area.

Year of manufacture can be taken from the first two digits in the serial number.

The devices shall be installed in a suitable enclosure providing a degree of protection of at least IP54 according to EN60529, taking into account the environmental conditions under which the equipment will be used.

When the temperature under rated conditions exceeds 70°C at the cable or conduit entry point, or 80°C at the branching point of the conductors, the temperature specification of the selected cable shall be in compliance with the actual measured temperature.

Provisions shall be made to prevent the rated voltage from being exceeded by transient disturbances of more than 40%.

For installation on power rail in Zone 2, only Power Rail type 9400 supplied by Power Control Unit type 9410 is allowed.

To prevent ignition of the explosive atmospheres, disconnect power before servicing and do not separate connectors when energised and an explosive gas mixture is present.

Do not mount or remove devices from the power rail when an explosive gas mixture is present.

Cleaning

When disconnected, the device may be cleaned with a cloth moistened with distilled water.

Liability

To the extent the instructions in this manual are not strictly observed, the customer cannot advance a demand against PR electronics A/S that would otherwise exist according to the concluded sales agreement.

Flexible supply

The technical specifications specifies the maximum required power at nominal operating values, e.g. 24 V supply voltage, 60°C ambient temperature, 600 Ω load, and 20 mA output current.

DIN rail solution - device daisy chain:

The 3101, 3102, 3111, 3112 and 3113 can be supplied with 24 VDC \pm 30% via direct wiring and a loop between the devices.

Power rail solution #2:

The 3405 power connector unit allows easy connection of a 24 VDC / 2.5 A source to the power rail.

Protective fuse: 2.5 A.

Protective fuse: 2.5 A.

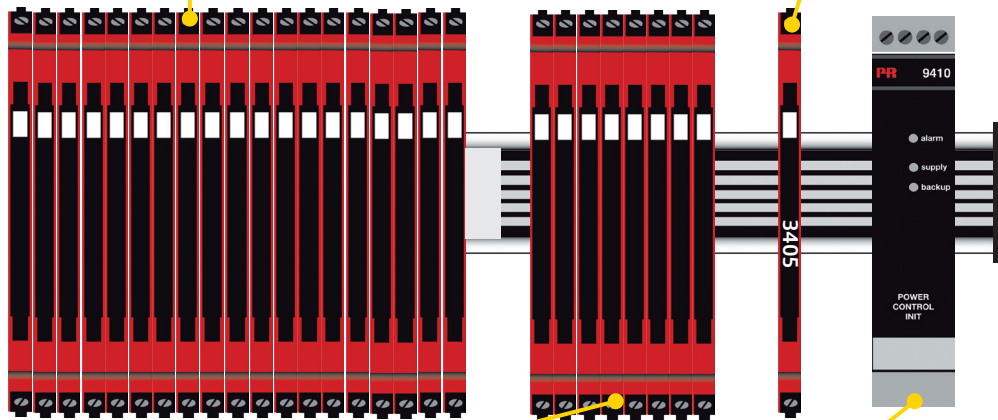

Protective fuse: 0.4 A.

Protective fuse: Located inside the PR 9410.

Power rail solution #1:

Alternately, you can connect 24 VDC to any one 3111, 3112, 3113 device with power rail connector which will then energize other units on the rail.

Power rail solution #3:

The 9410 power control unit can energize and power 96 W to the rail. Redundant power supplies are possible.

Note:

Device type 3101, 3102, 3111-N, 3112-N, 3113-N, 3331, 3333 and 3337 can only be supplied via the DIN rail solution with direct wiring on each device.

(*) External fuse characteristics:

The 2.5 A fuse must break after not more than 120 seconds at 6.4 A.

Mounting and demounting of system 3000

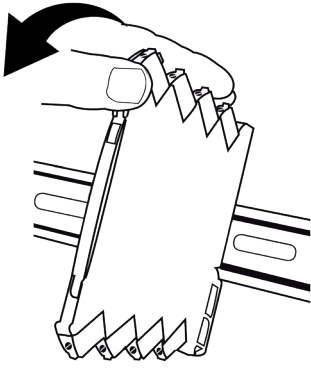

Picture 1:
Mounting on DIN rail / power rail.
Click the device onto the rail.

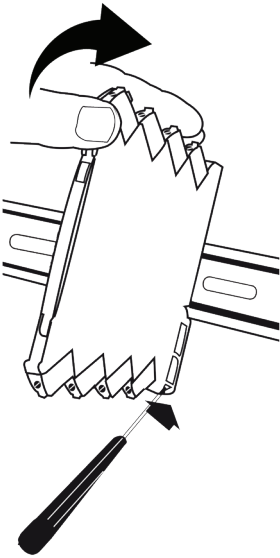

Picture 2:
Demounting from DIN rail / power rail.
First, remember to demount the connectors with hazardous voltages.
Detach the device from the DIN rail by lifting the bottom lock.

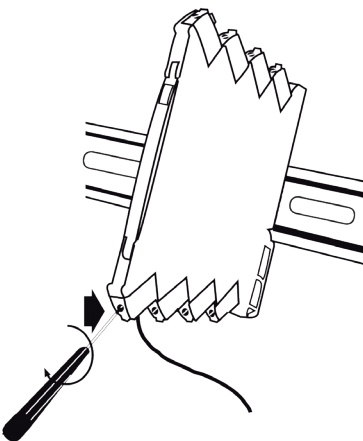

Picture 3:
Wire size AWG 26-12 / 0.13 x 2.5 mm² stranded wire.
Screw terminal torque 0.5 Nm.

Installation on DIN rail / power rail

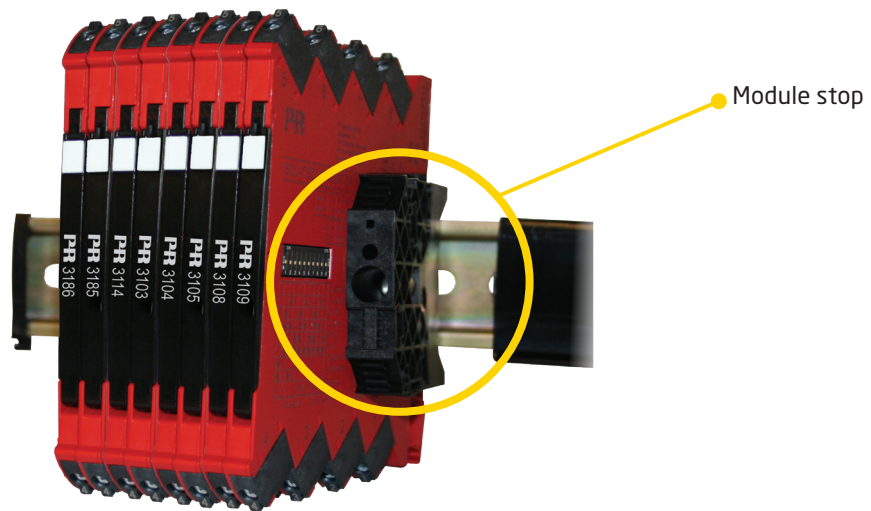

The devices in the 3000 series can be installed on a DIN rail or on a power rail (only 3111, 3112 and 3113). For marine applications the devices must be supported by a module stop (PR part number 9404). Power supply units can be mounted on the power rail according to customer requirements.

If you want to install a 3111, 3112 or 3113 device with power rail connectors on a standard DIN rail, the head of the screws holding the 7.5 mm DIN rail shall be no more than 3.5 mm high in order to avoid short circuit between the power rail connectors on the 3000 device and the screws.

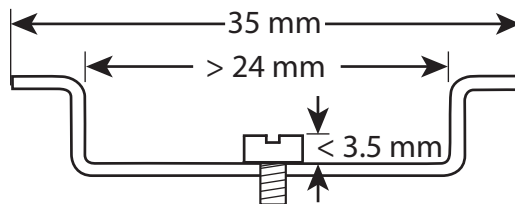

Supply of power rail

It is possible to supply the power rail via the supply terminals. The terminals can pass a current of max. 400 mA.

Marking

The front cover of the 3000 devices has been designed with an area for affixation of a click-on marker. The area assigned to the marker measures 5 x 7.5 mm. Markers from Weidmüller's MultiCard System, type MF 5/7.5, are suitable.

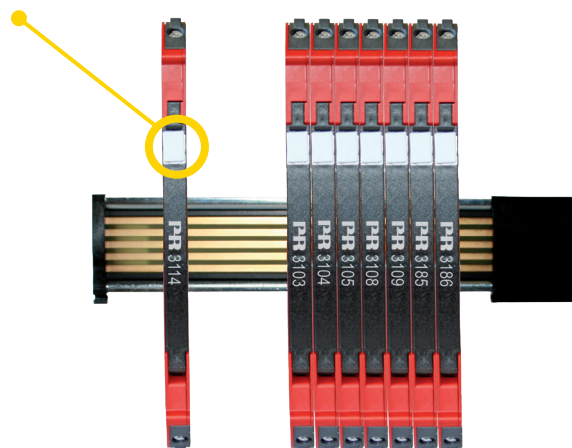

Side label

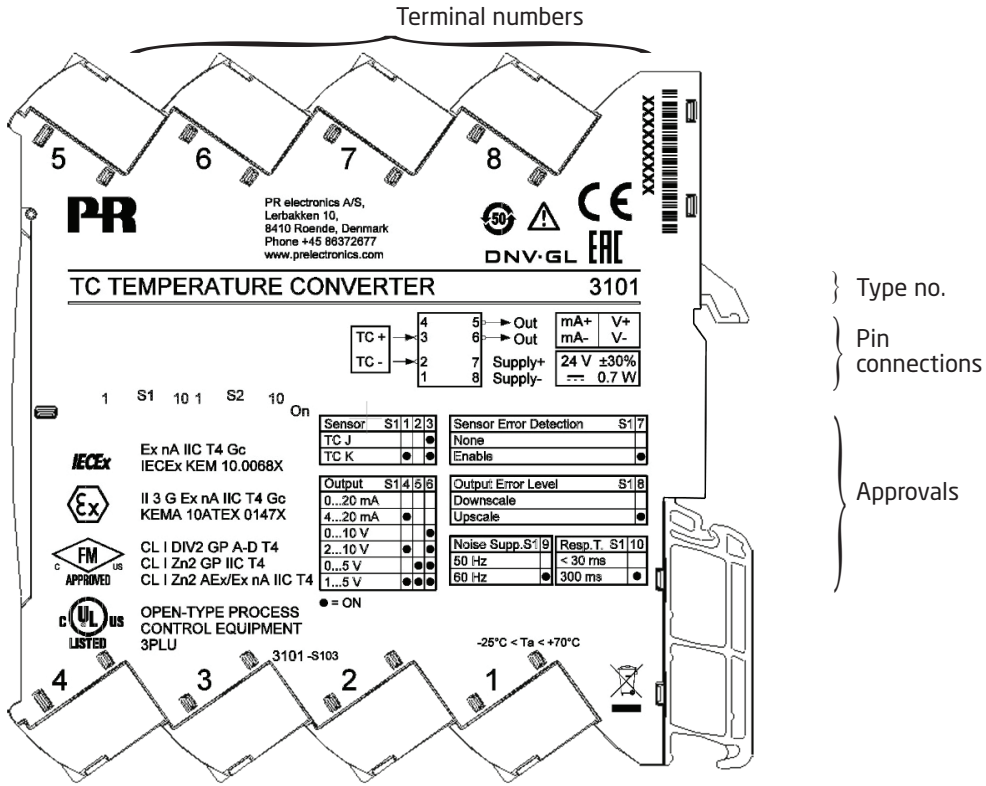

6 mm series of temperature and converters

3101 / 3102 / 3111 / 3112 / 3113 / 3331 / 3333 / 3337

- Converts process measurements from Pt100, TC J and K temperature sensors to voltage or current outputs
- Multiple pre-calibrated temperature ranges are selectable via DIP-switches
- High accuracy, better than 0.05% and excellent 50/60 Hz noise suppression
- Fast signal response time < 30 ms
- 3113 and 3337 with HART 7 protocol and fast signal response time < 60 ms
- HART 7 protocol enables extended device programming for 3113 and 3337
- Slimline 6 mm housing

Applications

- The temperature converters measure standard 2-, 3- or 4-wire Pt100 and/or TC J & K temperature sensors, and provides an analog voltage or current output.
- High 3 port isolation provides surge suppression and protects the control system from transients and noise.
- The loop powered devices have high 2-port galvanic separation to eliminate ground loops.
- The devices can be mounted in the Safe area or in Zone 2 / Division 2 areas.
- Approved for marine applications.

Technical characteristics

- High conversion accuracy, better than 0.05% of span.
- A visible green LED indicates operational status and status of the input sensor.
- All terminals are protected against overvoltage and polarity error.
- Meeting the NAMUR NE21 recommendations, the system 3000 devices ensure top measurement performance in harsh EMC environments.
- The devices meet the NAMUR NE43 standard defining out of range and sensor error output values.
- High galvanic isolation of 2.5 kVAC.
- Excellent signal/noise ratio of > 60 dB.

Mounting / installation

- Selectable DIP-mode for easy configuration of more than 1000 factory calibrated measurement ranges with HART read only feature.
- The narrow 6 mm housing and very low power consumption allows up to 165 units to be mounted per meter of DIN rail, without any air gap between units.
- Wide temperature operation range of -25...+70°C.

Order codes

	Input				Output			LED	Supply	Isolated	HART
	TC			Pt100	Current		Voltage				
	J & K	Int. CJC	Ext. CJC	2-, 3-, 4-wire	Active	Passive					
3101	✓	✓			✓		✓	✓	24 VDC		
3102				✓	✓		✓	✓	24 VDC		
3111	✓	✓	✓		✓		✓	✓	24 VDC / power rail	2.5 kV	
3111-N	✓	✓	✓		✓		✓	✓	24 VDC	2.5 kV	
3112				✓	✓		✓	✓	24 VDC / power rail	2.5 kV	
3112-N				✓	✓		✓	✓	24 VDC	2.5 kV	
3113	✓	✓	✓	✓	✓			✓	24 VDC / power rail	2.5 kV	✓
3113-N	✓	✓	✓	✓	✓			✓	24 VDC	2.5 kV	✓
3331	✓	✓	✓	✓		✓			Loop-powered	2.5 kV	
3333				✓		✓			Loop-powered		
3337	✓	✓	✓	✓		✓			Loop-powered	2.5 kV	✓

Accessories

9404 = Module stop for rail

Accessories for power rail devices

- 3405 = Power rail connector unit
- 9400 = Power rail - 7.5 or 15 mm high
- 9410 = Power control unit
- 9421 = Power supply

Technical data

Environmental conditions:

Operating temperature -25°C to +70°C
 Storage temperature -40°C to +85°C
 Calibration temperature. 20...28°C
 Relative humidity < 95% RH (non-cond.)
 Protection degree IP20
 Installation in pollution degree 2 & overvoltage category II.

Mechanical specifications:

Dimensions (HxWxD) 113 x 6.1 x 115 mm
 Weight approx. 70 g
 DIN rail type. DIN EN 60715 - 35 mm
 Wire size. 0.13...2.5 mm² / AWG 26...12 stranded wire
 Screw terminal torque. 0.5 Nm
 Vibration. IEC 60068-2-6
 2...25 Hz. ±1,6 mm
 25...100 Hz. ±4 g

Common electrical specifications:

Supply voltage, 24 VDC nom. 16.8...31.2 VDC

Loop-powered:

3331. 5.5...35 VDC

3333. 3.3...35 VDC

3337. 6.2...35 VDC

Power requirements:

Type	Max. power dissipation	Max. required power
3101	0.52	0.52
3102	0.52	0.52
3111	0.70	0.70
3112	0.70	0.70
3113	0.70	0.70
3331	0.80	0.80
3333	0.80	0.80
3337	0.80	0.80

Max. required power is the maximum power needed at power supply terminals or rail connector.

Max. power dissipation is the maximum power dissipated at nominal operating values.

Isolation voltage, test. 2.5 kVAC

Isolation voltage working. 300 VAC (reinforced) /
250 VAC (Zone 2, Div. 2)

Double isolation Input / output 1 / output 2 / supply

Signal dynamics, input 23 bit

Signal dynamics, output 18 bit

Signal / noise ratio. Min. 60 dB

Long-term stability, better than (only 3113) ±0.1% of span / year (±0.3% of span / 5 years)

	Response time			
	Selectable		HART read only mode	HART mode
	< 30 ms	< 300 ms	< 60 ms	0.06...60 s
3101	✓	✓		
3102	✓	✓		
3111	✓	✓		
3112	✓	✓		
3113			✓	✓
3331	✓	✓		
3333	✓	✓		
3337			✓	✓

Incorrect DIP-sw setting identification:

Supplied. 0 V / 0 mA output; LED 0.5 s / 1 Hz

Loop-powered 3.5 mA output

Device	Input	Basic accuracy	General accuracy	Temperature coefficient
3112, 3113, 3331, 3337	Pt100	$\leq 0.1^{\circ}\text{C}$	$\leq \pm 0.05\%$ of span	0.02°C/°C (basic) or $\leq \pm 0.01\%$ of span / °C
3111, 3113, 3331, 3337	TC	$\leq 0.5^{\circ}\text{C}$		0.1°C/°C (basic) or $\leq \pm 0.01\%$ of span / °C
3102, 3333	Pt100	$\leq 0.2^{\circ}\text{C}$	$\leq \pm 0.1\%$ of span	0.02°C/°C (basic) or $\leq \pm 0.01\%$ of span / °C
3101	TC	$\leq 1^{\circ}\text{C}$		0.1°C/°C (basic) or $\leq \pm 0.01\%$ of span / °C

EMC immunity influence $< \pm 0.5\%$ of span

Extended EMC immunity:

NAMUR NE 21 $< \pm 1\%$ of span

Input specifications:

Specifications for Pt100 input:

Temperature range, Pt100 -200...+850°C - IEC 60751
 Min. measuring range (span) 10°C
 Sensor current $< 150 \mu\text{A}$
 Sensor cable resistance $< 50 \Omega$ per wire
 Effect of sensor cable resistance, 3- / 4-wire $< 0.002 \Omega / \Omega$
 Sensor error detection Yes - selectable via DIP-switch
 Broken sensor detection $> 800 \Omega$
 Shorted sensor detection. $< 18 \Omega$

Specifications for TC input:

Temperature range, TC J. -100...+1200°C - IEC 60584-1
 Min. measuring range (span) 50°C
 Temperature range, TC K -180...+1372°C - IEC 60584-1
 Min. measuring range (span) 50°C
 Sensor cable resistance. $< 5 \text{ k}\Omega$ per wire
 Cold junction compensation (CJC) accuracy:
 Accuracy @ external Pt100 Better than $\pm 0.15^{\circ}\text{C}$
 Accuracy @ internal CJC Better than $\pm 2.5^{\circ}\text{C}$
 Open Thermocouple detection. Yes - selectable via DIP-switch
 Internal CJC error detection. Yes
 External CJC error detection Yes - selectable via DIP-switch

Output specifications:

	Current output							
	Active	Passive	Selectable			NAMUR NE43		Max. load
			Invert	Range	Limit	Sensor error	Range 4...20 mA	
3101	✓			0/4...20 mA	0/3.8...20.5 mA	0/3.5/23 mA	✓	≤ 600 Ω
3102	✓			0/4...20 mA	0/3.8...20.5 mA	0/3.5/23 mA	✓	≤ 600 Ω
3111	✓			0/4...20 mA	0/3.8...20.5 mA	0/3.5/23 mA	✓	≤ 600 Ω
3112	✓			0/4...20 mA	0/3.8...20.5 mA	0/3.5/23 mA	✓	≤ 600 Ω
3113	✓			4...20 mA	0/3.8...20.5 mA	0/3.5/23 mA	✓	≤ 600 Ω
3331		✓	✓	4...20 mA	3.8...20.5 mA	3.5 / 23 mA	✓	(V _{supply} -5.5)/0.023 [Ω]
3333		✓	✓	4...20 mA	3.8...20.5 mA	3.5 / 23 mA	✓	(V _{supply} -3.3)/0.023 [Ω]
3337		✓	✓	4...20 mA	3.8...20.5 mA	3.5 / 23 mA	✓	(V _{supply} -6.2)/0.023 [Ω]

Updating time 10 ms

Load stability ≤ 0.01% of span / 100 Ω

	Selectable voltage output						
	Low range			High range			Min. load
	Range	Limit	Sensor error	Range	Limit	Sensor error	
3101, 3102, 3111, 3112	0/1...5 V	0/0.875...5.125 V	0/5.5 V	0/2...10 V	0/1.75...10.25 V	0/11 V	10 kΩ

of span = of the selected range

Observed authority requirements:

EMC 2014/30/EU
 EMC Emission CISPR 22, Class B
 LVD 2014/35/EU
 RoHS 2011/65/EU

Approvals:

DNV-GL, Ships & Offshore Standard for Certification No. 2.4
 UL, Standard for Safety UL 61010-1
 Safe Isolation EN 61140
 EAC TR-CU 020/2011

I.S. / Ex approvals:

ATEX 2014/34/EU KEMA 10ATEX0147 X
 IECEx KEM 10.0068 X
 c FM us. FM17US0004X / FM17CA0003X
 CCOE P337347/1

Connections

Input wiring

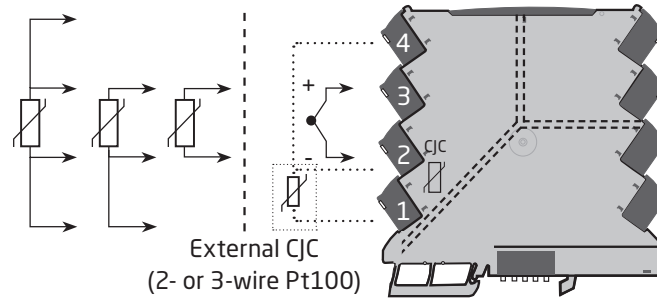

			+	-	CJC	Type
-	-	-	3	2	Y*	3101
1,2 & 3,4	1,2 & 3	2 & 3	-	-	N	3102
-	-	-	3	2	Y	3111
1,2 & 3,4	1,2 & 3	2 & 3	-	-	N	3112
1,2 & 3,4	1,2 & 3	2 & 3	3	2	Y	3113
1,2 & 3,4	1,2 & 3	2 & 3	3	2	Y	3331
1,2 & 3,4	1,2 & 3	2 & 3	-	-	N	3333
1,2 & 3,4	1,2 & 3	2 & 3	3	2	Y	3337

*3101 - only internal CJC

Output wiring

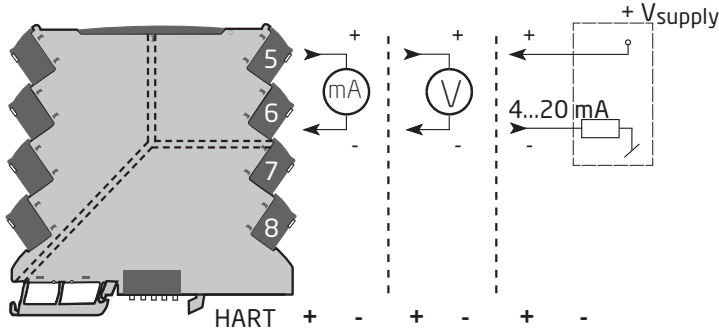

3101	N	5 : 6	5 : 6	-	-
3102	N	5 : 6	5 : 6	-	-
3111	N	5 : 6	5 : 6	-	-
3111-N	N	5 : 6	5 : 6	-	-
3112	N	5 : 6	5 : 6	-	-
3112-N	N	5 : 6	5 : 6	-	-
3113	Y	5 : 6	-	-	-
3113-N	Y	5 : 6	-	-	-
3331	N	-	-	5	6
3333	N	-	-	5	6
3337	Y	-	-	5	6
3405	N	-	-	-	-

Supply wiring

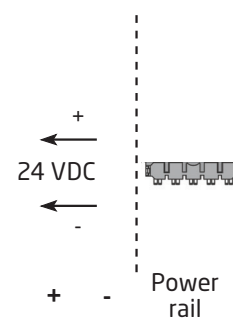

7	8	N
7	8	N
7	8	Y
7	8	N
7	8	Y
7	8	N
7	8	Y
7	8	N
-	-	N
-	-	N
-	-	N
7	8	Y

3101, 3102 and 3333: No galvanic isolation
 3331 and 3337: 2 port isolation (reinforced)
 3111, 3112 and 3113: 3 port isolation (reinforced)

Front led indications

For 3101, 3102, 3111, 3112 and 3113

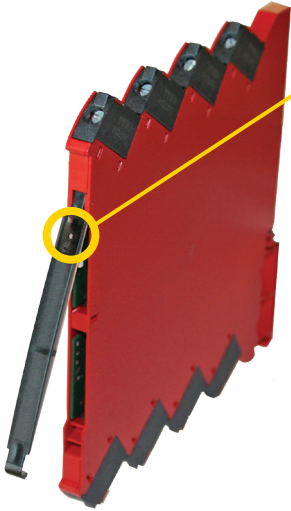

The device is equipped with a green power LED in the front to indicate the operation status, see the table below.

Condition	LED	Output	Action required
No supply / device error	OFF	De-energized	Connect supply / replace device
Power-up or restart	1 Flash (0.5 s OFF + 0.5 s ON)	De-energized	-
Device OK	Flashing 13 Hz (15 ms ON)	Energized	-
Incorrect DIP-switch setting	Flashing 1 Hz (500 ms ON)	De-energized	Correct setting and re-power device
Sensor error indication	Flashing 1 Hz (15 ms ON)	Up- or Downscale	Check sensor

DIP-switch configuration

The devices can be configured via DIP-switches. The DIP-switches are located on the side of the device and can be adjusted with a small screwdriver or other implement.

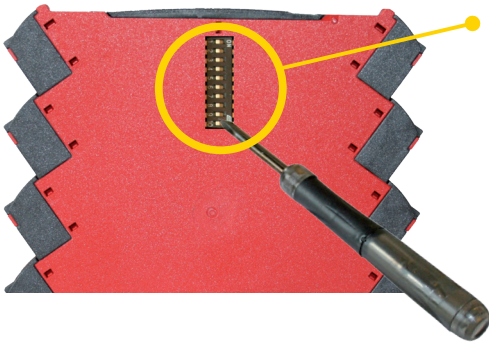

Default configurations

	3102, 3112, 3331, 3333	3101, 3111	3113, 3337
Sensor type	Pt100, 3 wire	TC K (int. CJC)	Pt100, 3 wire
Output range	4...20 mA	4...20 mA	4...20 mA
Error detection	Short circuit detection Broken circuit detection	Short circuit detection	Short circuit detection Broken circuit detection
Error output current	3.5 mA	3.5 mA	3.5 mA
Noise suppression	50 Hz	50 Hz	50 Hz
Input lower limit	0°C	0°C	0°C
Input upper limit	150°C	600°C	150°C
Response time	< 30 ms	< 30 ms	< 60 ms
Configuration mode	-	-	DIP switch configuration

3101 and 3111 TC J & K

Sensor S1 1 2 3	Sensor Error Detection S1 7
TC J (int. cjc) ● ● ●	None
TC K (int. cjc) ● ● ●	Enable ●
TC J (ext. cjc) ● ● ●	
TC K (ext. cjc) ● ● ●	
Output S1 4 5 6	Output Error Level S1 8
0...20 mA ● ● ●	Downscale
4...20 mA ● ● ●	Upscale ●
0...10 V ● ● ●	Noise Supp. S1 9
2...10 V ● ● ●	50 Hz ●
0...5 V ● ● ●	60 Hz ●
1...5 V ● ● ●	Resp.T. S1 10
● = ON	< 30 ms ●
	300 ms ●
	*3101 - only int CJC

3102 and 3112 Pt100

Sensor S1 1 2 3	Sensor Error Detection S1 7
Pt100, 2w ● ● ●	None
Pt100, 3w ● ● ●	Enable ●
Pt100, 4w ● ● ●	
Output S1 4 5 6	Output Error Level S1 8
0...20 mA ● ● ●	Downscale
4...20 mA ● ● ●	Upscale ●
0...10 V ● ● ●	Noise Supp. S1 9
2...10 V ● ● ●	50 Hz ●
0...5 V ● ● ●	60 Hz ●
1...5 V ● ● ●	Resp.T. S1 10
● = ON	< 30 ms ●
	300 ms ●

3113 and 3337 Pt100 & TC J/K + HART

Sensor S1 1 2 3	Sensor Error Detection S1 7
Pt100, 2w ● ● ●	None
Pt100, 3w ● ● ●	Enable ●
Pt100, 4w ● ● ●	
TC J (int. CJC) ● ● ●	Output Error Level S1 8
TC K (int. CJC) ● ● ●	Downscale
TC J (Ext. CJC) ● ● ●	Upscale ●
TC K (Ext. CJC) ● ● ●	Noise Supp. S1 9
Output S1 4 5 6	50 Hz ●
4...20 mA ● ● ●	60 Hz ●
20...4 mA ● ● ●	Resp.T. S1 10
● = ON	< 30 ms ●
	300 ms ●
	Config. S1 10
	DIP ●
	HART ●

3331 Pt100 & TC J/K

Sensor S1 1 2 3	Sensor Error Detection S1 7
Pt100, 2w ● ● ●	None
Pt100, 3w ● ● ●	Enable ●
Pt100, 4w ● ● ●	
TC J (int. CJC) ● ● ●	Output Error Level S1 8
TC K (int. CJC) ● ● ●	Downscale
TC J (Ext. CJC) ● ● ●	Upscale ●
TC K (Ext. CJC) ● ● ●	Noise Supp. S1 9
Output S1 4 5 6	50 Hz ●
4...20 mA ● ● ●	60 Hz ●
20...4 mA ● ● ●	Resp.T. S1 10
● = ON	< 30 ms ●
	300 ms ●

3333 Pt100

Sensor S1 1 2 3	Sensor Error Detection S1 7
Pt100, 2w ● ● ●	None
Pt100, 3w ● ● ●	Enable ●
Pt100, 4w ● ● ●	
Output S1 4 5 6	Output Error Level S1 8
4...20 mA ● ● ●	Downscale
20...4 mA ● ● ●	Upscale ●
● = ON	Noise Supp. S1 9
	50 Hz ●
	60 Hz ●
	Resp.T. S1 10
	< 30 ms ●
	300 ms ●

(Power must be cycled after DIP-switch positions are changed).

Temperature range programming

DIP S2				● = ON										Temperature Range °C											
Start Temp.	1	2	3	4	End Temp.	5	6	7	8	9	10	End Temp.	5	6	7	8	9	10	End Temp.	5	6	7	8	9	10
-200					0							105		●		●		●	375		●		●		●
-180				●	5						●	110		●		●	●		400		●		●		●
-150			●		10						●	115		●		●	●		450		●		●		●
-100			●	●	15						●	120		●	●				500		●		●		●
-50		●			20					●	●	125		●	●			●	550		●		●		●
-25		●		●	25					●	●	130		●	●			●	600		●		●		●
-10		●	●		30					●	●	135		●	●			●	650		●				●
-5		●	●	●	35					●	●	140		●	●			●	700		●				●
0	●				40			●				145		●	●	●		●	750		●			●	
5	●			●	45			●			●	150		●	●	●		●	800		●			●	
10	●		●		50			●		●		160		●	●	●	●		850		●		●		
20	●		●	●	55			●		●	●	170		●					900		●		●		●
25	●	●			60			●	●			180		●					950		●		●		●
50	●	●		●	65			●	●		●	190		●				●	1000		●		●		●
100	●	●	●		70			●	●	●		200		●				●	1050		●		●		●
200	●	●	●	●	75			●	●	●	●	225		●			●		1100		●		●		●
					80			●				250		●			●		1150		●			●	
					85			●			●	275		●			●		1200		●		●		●
					90			●			●	300		●			●		1250		●		●		●
					95			●			●	325		●			●		1300		●		●		●
					100			●		●		350		●			●		1350		●		●		●
																			1372		●		●		●

Sens. type :	Temp. range °C :
Pt100	-200 - +850°C
TC J	-100 - +1200°C
TC K	-180 - +1372°C

Please note:

- 3101 and 3111 - only TC input available
Valid TC J range: -100...+1200°C = correct DIP-switch setting
Valid TC K range: -180...+1372°C = correct DIP-switch setting
- 3102, 3112 and 3333 - only Pt100 input available
Valid Pt100 range: -200...+850°C = correct DIP-switch setting
- "Start temp" must be lower than "End temp" = correct DIP-switch setting
- Power must be cycled after DIP-switch positions are changed

Document history

The following list provides notes concerning revisions of this document.

Rev. ID	Date	Notes
103	1803	Models 31xx-N added Specifications for max. required power and power dissipation added

We are near you, *all over the world*

Our trusted red boxes are supported wherever you are

All our devices are backed by expert service and a 5-year warranty. With each product you purchase, you receive personal technical support and guidance, day-to-day delivery, repair without charge within the warranty period and easily accessible documentation.

We are headquartered in Denmark, and have offices and authorized partners the world over. We are a local

business with a global reach. This means that we are always nearby and know your local markets well. We are committed to your satisfaction and provide **PERFORMANCE MADE SMARTER** all around the world.

For more information on our warranty program, or to meet with a sales representative in your region, visit prelectronics.com.

Benefit today from *PERFORMANCE MADE SMARTER*

PR electronics is the leading technology company specialized in making industrial process control safer, more reliable and more efficient. Since 1974, we have been dedicated to perfecting our core competence of innovating high precision technology with low power consumption. This dedication continues to set new standards for products communicating, monitoring and connecting our customers' process measurement points to their process control systems.

Our innovative, patented technologies are derived from our extensive R&D facilities and from having a great understanding of our customers' needs and processes. We are guided by principles of simplicity, focus, courage and excellence, enabling some of the world's greatest companies to achieve PERFORMANCE MADE SMARTER.